

Varenummer: 03446025
Beskrivelse: Fluro Heavy Duty Ledleje GE 25 GW-2RS
Hul Ø25
Note: 25

Mål

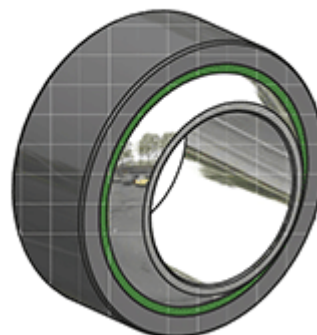
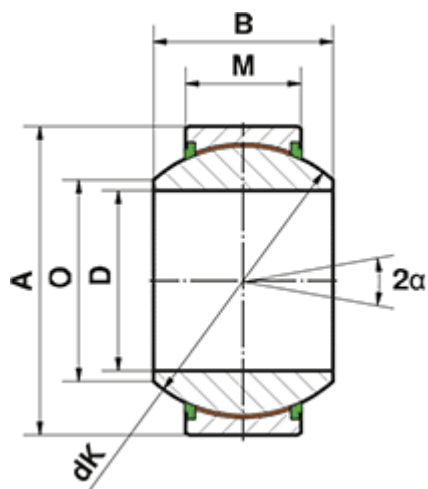

= -	Dynamisk belastning C (kN) = 162
= -	M = 18
= -	O = 29.5
A = 47	Statisk belastning C0 (kN) = 272
a (grader) = 17	Vægt (g) = 203
B = 28	
D = 25	
dK = 40.7	